













Pegasus
hydraulics

Compression fittings
with O-ring seals to
DIN EN ISO 8434-1





	Product Groups	Page
	Assembly instructions	9.02
	Straight female female coupling	9.03
	Straight female female reducing couplings	
	L to L series and S to S series	9.04
	L to S series and S to L series	9.05
	Adjustable elbows	
	Adjustable female elbow	9.06
	Adjustable female elbow with metric parallel captive seal male stud	9.07
	Adjustable female elbow with BSP parallel captive seal male stud	9.08
	Adjustable 45° elbow	9.09
	Adjustable branch tees	
	Adjustable female branch tee	9.10
	Adjustable female branch tee with metric parallel captive seal male stud	9.11
	Adjustable female branch tee with BSP parallel captive seal male stud	9.12
	Adjustable run tees	
	Adjustable female run tee	9.13
	Adjustable female run tee with metric parallel captive seal male stud	9.14
	Adjustable female run tee with BSP parallel captive seal male stud	9.15
	Straight female to male reducing couplings	
	L series	9.16
	S series	9.17
	Swivel female to male adapters	
	Swivel female to metric parallel male	9.18
	Swivel female to BSP parallel male	9.19
	Swivel female to NPT male	9.20
	Swivel female to gauge female	9.21
	Distance adapter	9.22

These fittings are compression fittings with a Viton O-ring seal. They are manufactured in accordance with ISO 8434-1 / DIN 2353.

1. The cone-sealing fittings are designed to be assembled into other fitting bodies of the same size.



2. Stainless steel fitting threads must be lubricated with assembly lubricants such as the Gleitmo 810 or High Tech Paste ASW 040 P, details of which are found in section 12. The threads can gall or cold-weld together if the assembler fails to use these lubricants.

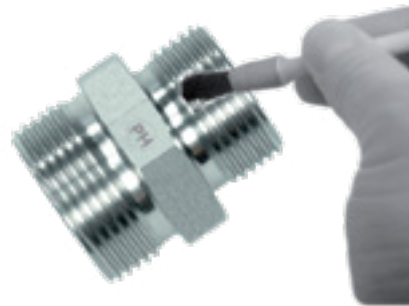

3. Screw the cone-sealing female nut onto the fitting body until hand tight.

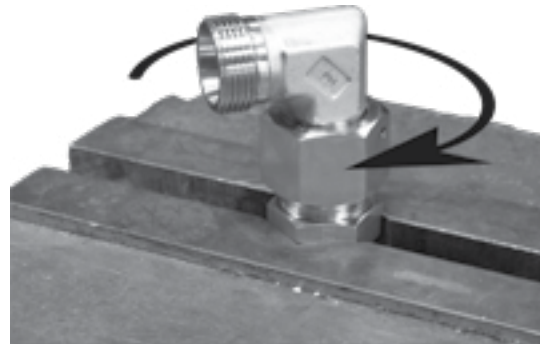

4. Then tighten it with a 1/4 turn (about 1½ hex nut flats).

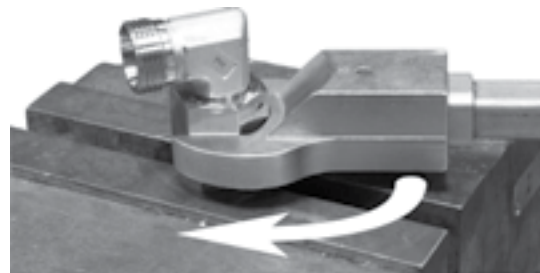

Straight female female coupling

BOOK INDEX

SECTION INDEX

24° female and Viton O-ring
with a profile to W DIN 3861

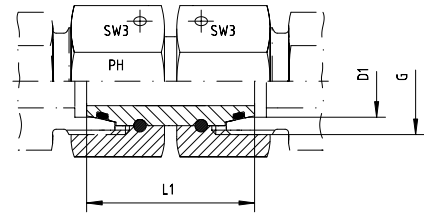

Series	Pressure PN	Tube O.D. D1	Thread G	Approx. Dimensions		Part code
				L1	SW3	
L	500	6	M 12 x 1.5	33.0	14	GV-DKOL-06
L	500	8	M 14 x 1.5	33.7	17	GV-DKOL-08
L	500	10	M 16 x 1.5	34.5	19	GV-DKOL-10
L	400	12	M 18 x 1.5	35.0	22	GV-DKOL-12
L	400	15	M 22 x 1.5	39.0	27	GV-DKOL-15
L	400	18	M 26 x 1.5	38.0	32	GV-DKOL-18
L	250	22	M 30 x 2	43.0	36	GV-DKOL-22
L	250	28	M 36 x 2	46.0	41	GV-DKOL-28
L	250	35	M 45 x 2	47.0	50	GV-DKOL-35
L	250	42	M 52 x 2	52.0	60	GV-DKOL-42

Series	Pressure PN	Tube O.D. D1	Thread G	Approx. Dimensions		Part code
				L1	SW3	
S	800	6	M 14 x 1.5	33.0	17	GV-DKOS-06
S	800	8	M 16 x 1.5	36.0	19	GV-DKOS-08
S	800	10	M 18 x 1.5	36.0	22	GV-DKOS-10
S	630	12	M 20 x 1.5	38.0	24	GV-DKOS-12
S	630	14	M 22 x 1.5	38.0	27	GV-DKOS-14
S	630	16	M 24 x 1.5	39.0	30	GV-DKOS-16
S	420	20	M 30 x 2	46.5	36	GV-DKOS-20
S	420	25	M 36 x 2	47.5	46	GV-DKOS-25
S	420	30	M 42 x 2	52.0	50	GV-DKOS-30
S	420	38	M 52 x 2	52.5	60	GV-DKOS-38

9

Straight female female reducing coupling

BOOK INDEX

SECTION INDEX

24° female and Viton O-ring
with a profile to W DIN 3861

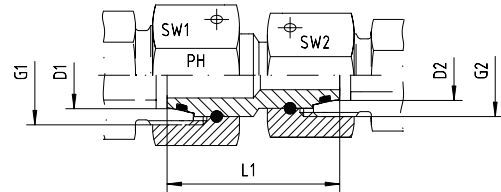

Series	Pressure PN	Tube O.D.		Thread		Approx. Dimensions			Part code
		D1	D2	G1	G2	L1	SW1	SW2	
L	500	8	6	M 14 x 1.5	M 12 x 1.5	31.0	17	14	GVR-DKO-08-L/06-L
L	500	10	6	M 16 x 1.5	M 12 x 1.5	34.0	19	14	GVR-DKO-10-L/06-L
L	500	10	8	M 16 x 1.5	M 14 x 1.5	33.0	19	17	GVR-DKO-10-L/08-L
L	400	12	6	M 18 x 1.5	M 12 x 1.5	34.0	22	14	GVR-DKO-12-L/06-L
L	400	12	8	M 18 x 1.5	M 14 x 1.5	34.0	22	17	GVR-DKO-12-L/08-L
L	400	12	10	M 18 x 1.5	M 16 x 1.5	33.0	22	19	GVR-DKO-12-L/10-L
L	400	15	8	M 22 x 1.5	M 14 x 1.5	37.0	27	17	GVR-DKO-15-L/08-L
L	400	15	10	M 22 x 1.5	M 16 x 1.5	38.0	27	19	GVR-DKO-15-L/10-L
L	400	15	12	M 22 x 1.5	M 18 x 1.5	35.0	27	22	GVR-DKO-15-L/12-L
L	400	18	10	M 26 x 1.5	M 16 x 1.5	36.3	32	19	GVR-DKO-18-L/10-L
L	400	18	12	M 26 x 1.5	M 18 x 1.5	38.0	32	22	GVR-DKO-18-L/12-L
L	400	18	15	M 26 x 1.5	M 22 x 1.5	43.0	32	27	GVR-DKO-18-L/15-L
L	250	22	12	M 30 x 2	M 18 x 1.5	42.0	36	22	GVR-DKO-22-L/12-L
L	250	22	15	M 30 x 2	M 22 x 1.5	43.5	36	27	GVR-DKO-22-L/15-L
L	250	22	18	M 30 x 2	M 26 x 1.5	43.0	36	32	GVR-DKO-22-L/18-L
L	250	28	15	M 36 x 2	M 22 x 1.5		41	27	GVR-DKO-28-L/15-L
L	250	28	18	M 36 x 2	M 26 x 1.5	46.0	41	32	GVR-DKO-28-L/18-L
L	250	28	22	M 36 x 2	M 30 x 2		41	36	GVR-DKO-28-L/22-L
L	250	35	18	M 45 x 2	M 26 x 1.5	44.0	50	32	GVR-DKO-35-L/18-L
L	250	35	22	M 45 x 2	M 30 x 2		50	36	GVR-DKO-35-L/22-L
L	250	35	28	M 45 x 2	M 36 x 2	46.5	50	41	GVR-DKO-35-L/28-L
L	250	42	22	M 52 x 2	M 30 x 2	47.0	60	36	GVR-DKO-42-L/22-L
L	250	42	28	M 52 x 2	M 36 x 2	47.5	60	41	GVR-DKO-42-L/28-L
L	250	42	35	M 52 x 2	M 45 x 2	52.0	60	50	GVR-DKO-42-L/35-L

Series	Pressure PN	Tube O.D.		Thread		Approx. Dimensions			Part code
		D1	D2	G1	G2	L1	SW1	SW2	
S	800	8	6	M 16 x 1.5	M 14 x 1.5	35.5	19	17	GVR-DKO-08-S/06-S
S	800	10	6	M 18 x 1.5	M 14 x 1.5	35.5	22	17	GVR-DKO-10-S/06-S
S	800	10	8	M 18 x 1.5	M 16 x 1.5	37.0	22	19	GVR-DKO-10-S/08-S
S	630	12	6	M 20 x 1.5	M 14 x 1.5	36.0	24	17	GVR-DKO-12-S/06-S
S	630	12	8	M 20 x 1.5	M 16 x 1.5	37.5	24	19	GVR-DKO-12-S/08-S
S	630	12	10	M 20 x 1.5	M 18 x 1.5	37.5	24	22	GVR-DKO-12-S/10-S
S	630	16	10	M 24 x 1.5	M 18 x 1.5	37.5	30	22	GVR-DKO-16-S/10-S
S	630	16	12	M 24 x 1.5	M 20 x 1.5	38.0	30	24	GVR-DKO-16-S/12-S
S	630	16	14	M 24 x 1.5	M 22 x 1.5	47.0	30	27	GVR-DKO-16-S/14-S
S	420	20	12	M 30 x 2	M 20 x 1.5	43.0	36	24	GVR-DKO-20-S/12-S
S	420	20	14	M 30 x 2	M 22 x 1.5		36	27	GVR-DKO-20-S/14-S
S	420	20	16	M 30 x 2	M 24 x 1.5	43.0	36	30	GVR-DKO-20-S/16-S
S	420	25	16	M 36 x 2	M 24 x 1.5	46.0	46	30	GVR-DKO-25-S/16-S
S	420	25	20	M 36 x 2	M 30 x 2	46.0	46	36	GVR-DKO-25-S/20-S
S	420	30	16	M 42 x 2	M 24 x 1.5	46.0	50	30	GVR-DKO-30-S/16-S
S	420	30	20	M 42 x 2	M 30 x 2	52.0	50	36	GVR-DKO-30-S/20-S
S	420	30	25	M 42 x 2	M 36 x 2	52.0	50	46	GVR-DKO-30-S/25-S
S	420	38	20	M 52 x 2	M 30 x 2	52.0	60	36	GVR-DKO-38-S/20-S
S	420	38	25	M 52 x 2	M 36 x 2	53.0	60	46	GVR-DKO-38-S/25-S
S	420	38	30	M 52 x 2	M 42 x 2	52.0	60	50	GVR-DKO-38-S/30-S

Straight female female reducing coupling

BOOK INDEX

SECTION INDEX

24° female and Viton O-ring
with a profile to W DIN 3861

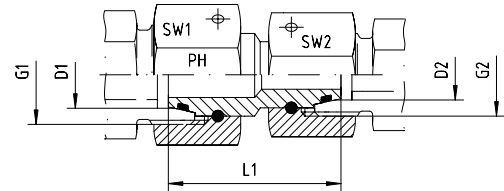

Series	Pressure PN	Tube O.D.		Thread		Approx. Dimensions			Part code
		D1	D2	G1	G2	L1	SW1	SW2	
L / S	500	6	6	M 14 x 1.5	M 12 x 1.5	33.0	17	14	GVR-DKO-06-L/06-S
L / S	500	8	6	M 14 x 1.5	M 14 x 1.5		17	17	GVR-DKO-08-L/06-S
L / S	500	8	8	M 16 x 1.5	M 14 x 1.5	35.0	19	17	GVR-DKO-08-L/08-S
L / S	500	10	10	M 18 x 1.5	M 16 x 1.5	35.3	22	19	GVR-DKO-10-L/10-S
L / S	400	12	10	M 18 x 1.5	M 18 x 1.5	32.5	22	22	GVR-DKO-12-L/10-S
L / S	400	12	12	M 20 x 1.5	M 18 x 1.5	37.0	24	22	GVR-DKO-12-L/12-S
L / S	400	15	12	M 22 x 1.5	M 20 x 1.5	38.5	27	24	GVR-DKO-15-L/12-S
L / S	400	15	14	M 22 x 1.5	M 22 x 1.5	44.5	27	27	GVR-DKO-15-L/14-S
L / S	400	18	16	M 26 x 1.5	M 24 x 1.5	40.0	32	30	GVR-DKO-18-L/16-S
L / S	250	22	20	M 30 x 2	M 30 x 2	53.0	36	36	GVR-DKO-22-L/20-S
L / S	250	28	25	M 36 x 2	M 36 x 2	46.0	46	41	GVR-DKO-28-L/25-S
L / S	250	35	30	M 45 x 2	M 42 x 2	51.0	50	50	GVR-DKO-35-L/30-S
L / S	250	42	38	M 52 x 2	M 52 x 2	52.0	60	60	GVR-DKO-42-L/38-S

Series	Pressure PN	Tube O.D.		Thread		Approx. Dimensions			Part code
		D1	D2	G1	G2	L1	SW1	SW2	
S / L	500	10	8	M 18 x 1.5	M 14 x 1.5	33.0	22	17	GVR-DKO-10-S/08-L
S / L	500	12	8	M 20 x 1.5	M 14 x 1.5	34.0	24	17	GVR-DKO-12-S/08-L
S / L	500	12	10	M 20 x 1.5	M 16 x 1.5	33.0	24	19	GVR-DKO-12-S/10-L
S / L	500	16	10	M 24 x 1.5	M 16 x 1.5	35.5	30	19	GVR-DKO-16-S/10-L
S / L	400	16	12	M 24 x 1.5	M 18 x 1.5	39.0	30	22	GVR-DKO-16-S/12-L
S / L	400	16	15	M 24 x 1.5	M 22 x 1.5	38.5	30	27	GVR-DKO-16-S/15-L
S / L	400	20	18	M 30 x 2	M 26 x 1.5	43.0	36	32	GVR-DKO-20-S/18-L
S / L	400	25	18	M 36 x 2	M 26 x 1.5	44.0	46	32	GVR-DKO-25-S/18-L
S / L	250	25	22	M 36 x 2	M 30 x 2	46.0	46	36	GVR-DKO-25-S/22-L
S / L	250	30	28	M 42 x 2	M 36 x 2	49.5	50	41	GVR-DKO-30-S/28-L
S / L	250	38	35	M 52 x 2	M 45 x 2	53.0	60	50	GVR-DKO-38-S/35-L

Adjustable female elbow

BOOK INDEX

SECTION INDEX

24° female and Viton O-ring
with a profile to W DIN 3861

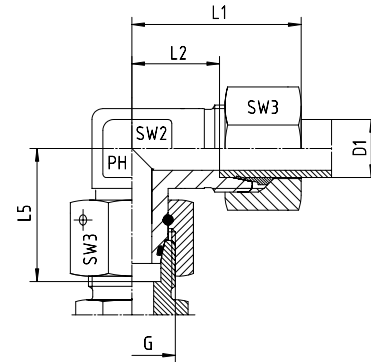

Series	Pressure PN	Tube O.D. D1	Thread G	Approx. Dimensions					Part code
				L1	L2	L5	SW2	SW3	
L	500	6	M 12 x 1.5	27	12.0	26.0	12	14	EW-DKOL-06
L	500	8	M 14 x 1.5	29	14.0	27.5	12	17	EW-DKOL-08
L	500	10	M 16 x 1.5	30	15.0	29.0	14	19	EW-DKOL-10
L	400	12	M 18 x 1.5	32	17.0	29.5	17	22	EW-DKOL-12
L	400	15	M 22 x 1.5	36	21.0	32.5	19	27	EW-DKOL-15
L	400	18	M 26 x 1.5	40	23.5	35.5	24	32	EW-DKOL-18
L	250	22	M 30 x 2	44	27.5	38.5	27	36	EW-DKOL-22
L	250	28	M 36 x 2	47	30.5	41.5	36	41	EW-DKOL-28
L	250	35	M 45 x 2	56	34.5	51.0	41	50	EW-DKOL-35
L	250	42	M 52 x 2	63	40.0	56.0	50	60	EW-DKOL-42

Series	Pressure PN	Tube O.D. D1	Thread G	Approx. Dimensions					Part code
				L1	L2	L5	SW2	SW3	
S	800	6	M 14 x 1.5	31	16.0	27.0	12	17	EW-DKOS-06
S	800	8	M 16 x 1.5	32	17.0	27.5	14	19	EW-DKOS-08
S	800	10	M 18 x 1.5	34	17.5	30.0	17	22	EW-DKOS-10
S	630	12	M 20 x 1.5	38	21.5	31.0	17	24	EW-DKOS-12
S	630	14	M 22 x 1.5	40	22.0	35.0	19	27	EW-DKOS-14
S	630	16	M 24 x 1.5	43	24.5	36.5	24	30	EW-DKOS-16
S	420	20	M 30 x 2	48	26.5	44.5	27	36	EW-DKOS-20
S	420	25	M 36 x 2	54	30.0	50.0	36	46	EW-DKOS-25
S	420	30	M 42 x 2	62	35.5	55.0	41	50	EW-DKOS-30
S	420	38	M 52 x 2	72	41.0	63.0	50	60	EW-DKOS-38

24° female and Viton O-ring
with a profile to W DIN 3861

Metric parallel male thread with
Viton elastomeric soft seal

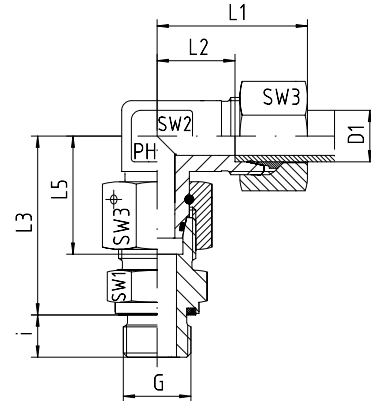

Series	Pressure PN	Tube O.D. D1	Thread G	Approx. Dimensions								Part code
				L1	L2	L3	L5	i	SW1	SW2	SW3	
L	500	6	M 10 x 1	27	12.0	34.5	26.0	8	14	12	14	EW-DKOL-06-M 10x1-wd
L	500	8	M 12 x 1.5	29	14.0	37.5	27.5	12	17	12	17	EW-DKOL-08-M 12x1.5-wd
L	500	10	M 14 x 1.5	30	15.0	40.0	29.0	12	19	14	19	EW-DKOL-10-M 14x1.5-wd
L	400	12	M 16 x 1.5	32	17.0	42.0	29.5	12	22	17	22	EW-DKOL-12-M 16x1.5-wd
L	400	15	M 18 x 1.5	36	21.0	46.0	32.5	12	24	19	27	EW-DKOL-15-M 18x1.5-wd
L	400	18	M 22 x 1.5	40	23.5	50.0	35.5	14	27	24	32	EW-DKOL-18-M 22x1.5-wd
L	250	22	M 26 x 1.5	44	27.5	55.0	38.5	16	32	27	36	EW-DKOL-22-M 26x1.5-wd
L	250	28	M 33 x 2	47	30.5	59.0	41.5	18	41	36	41	EW-DKOL-28-M 33x2-wd
L	250	35	M 42 x 2	56	34.5	68.5	51.0	20	50	41	50	EW-DKOL-35-M 42x2-wd
L	250	42	M 48 x 2	63	40.0	75.0	56.0	22	55	50	60	EW-DKOL-42-M 48x2-wd

Series	Pressure PN	Tube O.D. D1	Thread G	Approx. Dimensions								Part code
				L1	L2	L3	L5	i	SW1	SW2	SW3	
S	800	6	M 12 x 1.5	31	16.0	40.0	27.0	12	17	12	17	EW-DKOS-06-M 12x1.5-wd
S	800	8	M 14 x 1.5	32	17.0	42.5	27.5	12	19	14	19	EW-DKOS-08-M 14x1.5-wd
S	800	10	M 16 x 1.5	34	17.5	45.0	30.0	12	22	17	22	EW-DKOS-10-M 16x1.5-wd
S	630	12	M 18 x 1.5	38	21.5	48.0	31.0	12	24	17	24	EW-DKOS-12-M 18x1.5-wd
S	630	14	M 20 x 1.5	40	22.0	54.0	35.0	14	27	19	27	EW-DKOS-14-M 20x1.5-wd
S	630	16	M 22 x 1.5	43	24.5	55.0	36.5	14	27	24	30	EW-DKOS-16-M 22x1.5-wd
S	420	20	M 27 x 2	48	26.5	65.0	44.5	16	32	27	36	EW-DKOS-20-M 27x2-wd
S	420	25	M 33 x 2	54	30.0	73.0	50.0	18	41	36	46	EW-DKOS-25-M 33x2-wd
S	420	30	M 42 x 2	62	35.5	78.5	55.0	20	50	41	50	EW-DKOS-30-M 42x2-wd
S	420	38	M 48 x 2	72	41.0	89.0	63.0	22	55	50	60	EW-DKOS-38-M 48x2-wd

24° female and Viton O-ring
with a profile to W DIN 3861

BSP parallel male thread with
Viton elastomeric soft seal

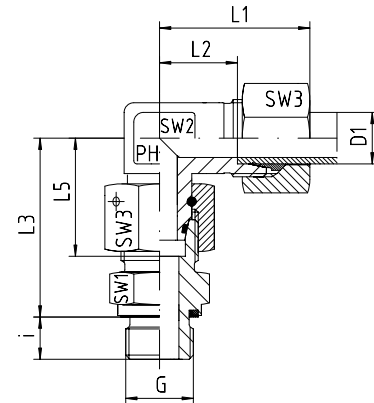

Series	Pressure PN	Tube O.D. D1	Thread G	Approx. Dimensions								Part code
				L1	L2	L3	L5	i	SW1	SW2	SW3	
L	500	6	G 1/8"	27	12.0	34.5	26.0	8	14	12	14	EW-DKOL-06-G 1/8"-wd
L	500	8	G 1/4"	29	14.0	37.5	27.5	12	17	12	17	EW-DKOL-08-G 1/4"-wd
L	500	10	G 1/4"	30	15.0	40.0	29.0	12	19	14	19	EW-DKOL-10-G 1/4"-wd
L	400	12	G 1/4"	32	17.0	42.0	29.5	12	19	17	22	EW-DKOL-12-G 1/4"-wd
L	400	12	G 3/8"	32	17.0	42.0	29.5	12	22	17	22	EW-DKOL-12-G 3/8"-wd
L	400	12	G 1/2"	32	17.0	43.0	29.5	14	27	17	22	EW-DKOL-12-G 1/2"-wd
L	400	15	G 1/2"	36	21.0	46.0	32.5	14	27	19	27	EW-DKOL-15-G 1/2"-wd
L	400	18	G 1/2"	40	23.5	50.0	35.5	14	27	24	32	EW-DKOL-18-G 1/2"-wd
L	250	22	G 3/4"	44	27.5	55.0	38.5	16	32	27	36	EW-DKOL-22-G 3/4"-wd
L	250	28	G 1"	47	30.5	59.0	41.5	18	41	36	41	EW-DKOL-28-G 1"-wd
L	250	35	G 1 1/4"	56	34.5	68.5	51.0	20	50	41	50	EW-DKOL-35-G 1 1/4"-wd
L	250	42	G 1 1/2"	63	40.0	75.0	56.0	22	55	50	60	EW-DKOL-42-G 1 1/2"-wd

Series	Pressure PN	Tube O.D. D1	Thread G	Approx. Dimensions								Part code
				L1	L2	L3	L5	i	SW1	SW2	SW3	
S	800	6	G 1/4"	31	16.0	40.0	27.0	12	19	12	17	EW-DKOS-06-G 1/4"-wd
S	800	8	G 1/4"	32	17.0	42.5	27.5	12	19	14	19	EW-DKOS-08-G 1/4"-wd
S	800	10	G 3/8"	34	17.5	45.0	30.0	12	22	17	22	EW-DKOS-10-G 3/8"-wd
S	630	12	G 3/8"	38	21.5	48.0	31.0	12	22	17	24	EW-DKOS-12-G 3/8"-wd
S	630	12	G 1/2"	38	21.5	49.0	31.0	14	27	17	24	EW-DKOS-12-G 1/2"-wd
S	630	14	G 1/2"	40	22.0	54.0	35.0	14	27	19	27	EW-DKOS-14-G 1/2"-wd
S	630	16	G 1/2"	43	24.5	55.0	36.5	14	27	24	30	EW-DKOS-16-G 1/2"-wd
S	420	20	G 3/4"	48	26.5	65.0	44.5	16	32	27	36	EW-DKOS-20-G 3/4"-wd
S	420	25	G 1"	54	30.0	73.0	50.0	18	41	36	46	EW-DKOS-25-G 1"-wd
S	420	30	G 1 1/4"	62	35.5	78.5	55.0	20	50	41	50	EW-DKOS-30-G 1 1/4"-wd
S	420	38	G 1 1/2"	72	41.0	89.0	63.0	22	55	50	60	EW-DKOS-38-G 1 1/2"-wd

Adjustable female 45° elbow

BOOK INDEX

SECTION INDEX

24° female and Viton O-ring
with a profile to W DIN 3861

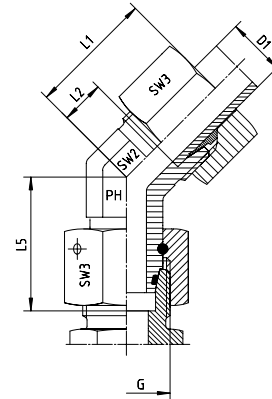

Series	Pressure PN	Tube O.D. D1	Thread G	Approx. Dimensions					Part code
				L1	L2	L5	SW2	SW3	
L	500	6	M 12 x 1.5	24	9.0	26.0	14	14	EV-DKOL-06
L	500	8	M 14 x 1.5	27	12.0	27.5	14	17	EV-DKOL-08
L	500	10	M 16 x 1.5	27	12.0	29.0	19	19	EV-DKOL-10
L	400	12	M 18 x 1.5	29	14.0	29.5	19	22	EV-DKOL-12
L	400	15	M 22 x 1.5	32	17.0	32.5	22	27	EV-DKOL-15
L	400	18	M 26 x 1.5	33	16.5	35.5	27	32	EV-DKOL-18
L	250	22	M 30 x 2	35	18.5	38.5	30	36	EV-DKOL-22
L	250	28	M 36 x 2	40	23.0	41.5	36	41	EV-DKOL-28
L	250	35	M 45 x 2	48	26.5	51.0	50	50	EV-DKOL-35
L	250	42	M 52 x 2	49	26.0	56.0	50	60	EV-DKOL-42

Series	Pressure PN	Tube O.D. D1	Thread G	Approx. Dimensions					Part code
				L1	L2	L5	SW2	SW3	
S	800	6	M 14 x 1.5	24	9.0	27.0	14	17	EV-DKOS-06
S	800	8	M 16 x 1.5	27	12.0	27.5	19	19	EV-DKOS-08
S	800	10	M 18 x 1.5	30	13.5	30.0	19	22	EV-DKOS-10
S	630	12	M 20 x 1.5	33	16.5	31.0	22	24	EV-DKOS-12
S	630	16	M 24 x 1.5	34	15.5	36.5	27	30	EV-DKOS-16
S	420	20	M 30 x 2	38	16.0	44.5	30	36	EV-DKOS-20
S	420	25	M 36 x 2	43	18.5	50.0	36	46	EV-DKOS-25
S	420	30	M 42 x 2	50	23.5	55.0	50	50	EV-DKOS-30
S	420	38	M 52 x 2	52	21.0	63.0	50	60	EV-DKOS-38

9

Adjustable female branch tee

BOOK INDEX

SECTION INDEX

24° female and Viton O-ring
with a profile to W DIN 3861

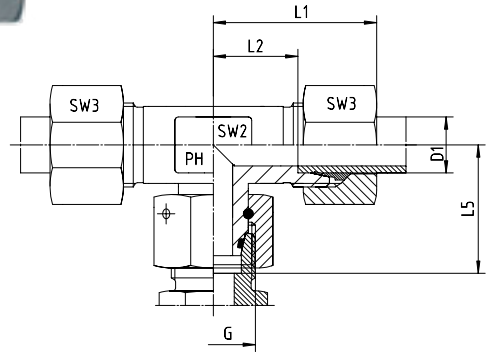

Series	Pressure PN	Tube O.D. D1	Thread G	Approx. Dimensions					Part code
				L1	L2	L5	SW2	SW3	
L	500	6	M 12 x 1.5	27	12.0	26.0	12	14	ET-DKOL-06
L	500	8	M 14 x 1.5	29	14.0	27.5	12	17	ET-DKOL-08
L	500	10	M 16 x 1.5	30	15.0	29.0	14	19	ET-DKOL-10
L	400	12	M 18 x 1.5	32	17.0	29.5	17	22	ET-DKOL-12
L	400	15	M 22 x 1.5	36	21.0	32.5	19	27	ET-DKOL-15
L	400	18	M 26 x 1.5	40	23.5	35.5	24	32	ET-DKOL-18
L	250	22	M 30 x 2	44	27.5	38.5	27	36	ET-DKOL-22
L	250	28	M 36 x 2	47	30.5	41.5	36	41	ET-DKOL-28
L	250	35	M 45 x 2	56	34.5	51.0	41	50	ET-DKOL-35
L	250	42	M 52 x 2	63	40.0	56.0	50	60	ET-DKOL-42

Series	Pressure PN	Tube O.D. D1	Thread G	Approx. Dimensions					Part code
				L1	L2	L5	SW2	SW3	
S	800	6	M 14 x 1.5	31	16.0	27.0	12	17	ET-DKOS-06
S	800	8	M 16 x 1.5	32	17.0	27.5	14	19	ET-DKOS-08
S	800	10	M 18 x 1.5	34	17.5	30.0	17	22	ET-DKOS-10
S	630	12	M 20 x 1.5	38	21.5	31.0	17	24	ET-DKOS-12
S	630	14	M 22 x 1.5	40	22.0	35.0	19	27	ET-DKOS-14
S	630	16	M 24 x 1.5	43	24.5	36.5	24	30	ET-DKOS-16
S	420	20	M 30 x 2	48	26.5	44.5	27	36	ET-DKOS-20
S	420	25	M 36 x 2	54	30.0	50.0	36	46	ET-DKOS-25
S	420	30	M 42 x 2	62	35.5	55.0	41	50	ET-DKOS-30
S	420	38	M 52 x 2	72	41.0	63.0	50	60	ET-DKOS-38

9

24° female and Viton O-ring
with a profile to W DIN 3861

Metric parallel male thread with
Viton elastomeric soft seal

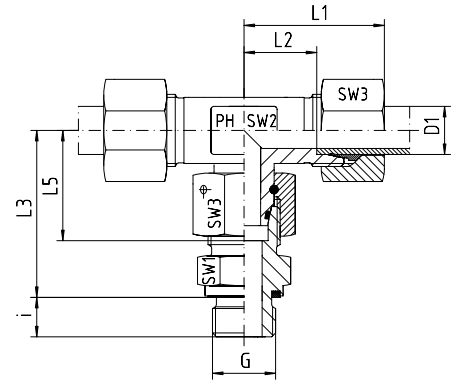

Series	Pressure PN	Tube O.D. D1	Thread G	Approx. Dimensions								Part code
				L1	L2	L3	L5	i	SW1	SW2	SW3	
L	500	6	M 10 x 1	27	12.0	34.5	26.0	8	14	12	14	ET-DKOL-06-M 10x1-wd
L	500	8	M 12 x 1.5	29	14.0	37.5	27.5	12	17	12	17	ET-DKOL-08-M 12x1.5-wd
L	500	10	M 14 x 1.5	30	15.0	40.0	29.0	12	19	14	19	ET-DKOL-10-M 14x1.5-wd
L	400	12	M 16 x 1.5	32	17.0	42.0	29.5	12	22	17	22	ET-DKOL-12-M 16x1.5-wd
L	400	15	M 18 x 1.5	36	21.0	46.0	32.5	12	24	19	27	ET-DKOL-15-M 18x1.5-wd
L	400	18	M 22 x 1.5	40	23.5	50.0	35.5	14	27	24	32	ET-DKOL-18-M 22x1.5-wd
L	250	22	M 26 x 1.5	44	27.5	55.0	38.5	16	32	27	36	ET-DKOL-22-M 26x1.5-wd
L	250	28	M 33 x 2	47	30.5	59.0	41.5	18	41	36	41	ET-DKOL-28-M 33x2-wd
L	250	35	M 42 x 2	56	34.5	68.5	51.0	20	50	41	50	ET-DKOL-35-M 42x2-wd
L	250	42	M 48 x 2	63	40.0	75.0	56.0	22	55	50	60	ET-DKOL-42-M 48x2-wd

Series	Pressure PN	Tube O.D. D1	Thread G	Approx. Dimensions								Part code
				L1	L2	L3	L5	i	SW1	SW2	SW3	
S	800	6	M 12 x 1.5	31	16.0	40.0	27.0	12	17	12	17	ET-DKOS-06-M 12x1.5-wd
S	800	8	M 14 x 1.5	32	17.0	42.5	27.5	12	19	14	19	ET-DKOS-08-M 14x1.5-wd
S	800	10	M 16 x 1.5	34	17.5	45.0	30.0	12	22	17	22	ET-DKOS-10-M 16x1.5-wd
S	630	12	M 18 x 1.5	38	21.5	48.0	31.0	12	24	17	24	ET-DKOS-12-M 18x1.5-wd
S	630	14	M 20 x 1.5	40	22.0	54.0	35.0	14	27	19	27	ET-DKOS-14-M 20x1.5-wd
S	630	16	M 22 x 1.5	43	24.5	55.0	36.5	14	27	24	30	ET-DKOS-16-M 22x1.5-wd
S	420	20	M 27 x 2	48	26.5	65.0	44.5	16	32	27	36	ET-DKOS-20-M 27x2-wd
S	420	25	M 33 x 2	54	30.0	73.0	50.0	18	41	36	46	ET-DKOS-25-M 33x2-wd
S	420	30	M 42 x 2	62	35.5	78.5	55.0	20	50	41	50	ET-DKOS-30-M 42x2-wd
S	420	38	M 48 x 2	72	41.0	89.0	63.0	22	55	50	60	ET-DKOS-38-M 48x2-wd

24° female and Viton O-ring
with a profile to W DIN 3861
BSP parallel male thread with
Viton elastomeric soft seal

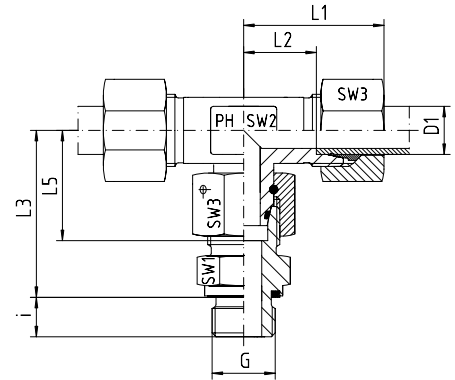

Series	Pressure PN	Tube O.D. D1	Thread G	Approx. Dimensions								Part code
				L1	L2	L3	L5	i	SW1	SW2	SW3	
L	500	6	G 1/8"	27	12.0	34.5	26.0	8	14	12	14	ET-DKOL-06-G 1/8"-wd
L	500	8	G 1/4"	29	14.0	37.5	27.5	12	17	12	17	ET-DKOL-08-G 1/4"-wd
L	500	10	G 1/4"	30	15.0	40.0	29.0	12	19	14	19	ET-DKOL-10-G 1/4"-wd
L	400	12	G 3/8"	32	17.0	42.0	29.5	12	22	17	22	ET-DKOL-12-G 3/8"-wd
L	400	15	G 1/2"	36	21.0	46.5	32.5	14	27	19	27	ET-DKOL-15-G 1/2"-wd
L	400	18	G 1/2"	40	23.5	50.0	35.5	14	27	24	32	ET-DKOL-18-G 1/2"-wd
L	250	22	G 3/4"	44	27.5	65.0	38.5	16	32	27	36	ET-DKOL-22-G 3/4"-wd
L	250	28	G 1"	47	30.5	59.0	41.5	18	41	36	41	ET-DKOL-28-G 1"-wd
L	250	35	G 1 1/4"	56	34.5	68.5	51.0	20	50	41	50	ET-DKOL-35-G 1 1/4"-wd
L	250	42	G 1 1/2"	63	40.0	75.0	56.0	22	55	50	60	ET-DKOL-42-G 1 1/2"-wd

Series	Pressure PN	Tube O.D. D1	Thread G	Approx. Dimensions								Part code
				L1	L2	L3	L5	i	SW1	SW2	SW3	
S	800	6	G 1/4"	31	16.0	40.0	27.0	12	19	12	17	ET-DKOS-06-G 1/4"-wd
S	800	8	G 1/4"	32	17.0	42.5	27.5	12	19	14	19	ET-DKOS-08-G 1/4"-wd
S	800	10	G 3/8"	34	17.5	45.0	30.0	12	22	17	22	ET-DKOS-10-G 3/8"-wd
S	630	12	G 3/8"	38	21.5	48.0	31.0	12	22	17	24	ET-DKOS-12-G 3/8"-wd
S	630	14	G 1/2"	40	22.0	54.0	35.0	14	27	19	27	ET-DKOS-14-G 1/2"-wd
S	630	16	G 1/2"	43	24.5	55.0	36.5	14	27	24	30	ET-DKOS-16-G 1/2"-wd
S	420	20	G 3/4"	48	26.5	65.0	44.5	16	32	27	36	ET-DKOS-20-G 3/4"-wd
S	420	25	G 1"	54	30.0	73.0	50.0	18	41	36	46	ET-DKOS-25-G 1"-wd
S	420	30	G 1 1/4"	62	35.5	78.5	55.0	20	50	41	50	ET-DKOS-30-G 1 1/4"-wd
S	420	38	G 1 1/2"	72	41.0	89.0	63.0	22	55	50	60	ET-DKOS-38-G 1 1/2"-wd

Adjustable female run tee

BOOK INDEX

SECTION INDEX

24° female and Viton O-ring
with a profile to W DIN 3861
BSP parallel male thread with
Viton elastomeric soft seal

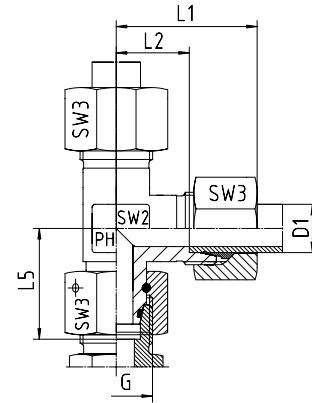

Series	Pressure PN	Tube O.D. D1	Thread G	Approx. Dimensions					Part code
				L1	L2	L5	SW2	SW3	
L	500	6	M 12 x 1.5	27	12.0	26.0	12	14	EL-DKOL-06
L	500	8	M 14 x 1.5	29	14.0	27.5	12	17	EL-DKOL-08
L	500	10	M 16 x 1.5	30	15.0	29.0	14	19	EL-DKOL-10
L	400	12	M 18 x 1.5	32	17.0	29.5	17	22	EL-DKOL-12
L	400	15	M 22 x 1.5	36	21.0	32.5	19	27	EL-DKOL-15
L	400	18	M 26 x 1.5	40	23.5	35.5	24	32	EL-DKOL-18
L	250	22	M 30 x 2	44	27.5	38.5	27	36	EL-DKOL-22
L	250	28	M 36 x 2	47	30.5	41.5	36	41	EL-DKOL-28
L	250	35	M 45 x 2	56	34.5	51.0	41	50	EL-DKOL-35
L	250	42	M 52 x 2	63	40.0	56.0	50	60	EL-DKOL-42

Series	Pressure PN	Tube O.D. D1	Thread G	Approx. Dimensions					Part code
				L1	L2	L5	SW2	SW3	
S	800	6	M 14 x 1.5	31	16.0	27.0	12	17	EL-DKOS-06
S	800	8	M 16 x 1.5	32	17.0	27.5	14	19	EL-DKOS-08
S	800	10	M 18 x 1.5	34	17.5	30.0	17	22	EL-DKOS-10
S	630	12	M 20 x 1.5	38	21.5	31.0	17	24	EL-DKOS-12
S	630	14	M 22 x 1.5	40	22.0	35.0	19	27	EL-DKOS-14
S	630	16	M 24 x 1.5	43	24.5	36.5	24	30	EL-DKOS-16
S	420	20	M 30 x 2	48	26.5	44.5	27	36	EL-DKOS-20
S	420	25	M 36 x 2	54	30.0	50.0	36	46	EL-DKOS-25
S	420	30	M 42 x 2	62	35.5	55.0	41	50	EL-DKOS-30
S	420	38	M 52 x 2	72	41.0	63.0	50	60	EL-DKOS-38

24° female and Viton O-ring
with a profile to W DIN 3861

Metric parallel male thread with
Viton elastomeric soft seal

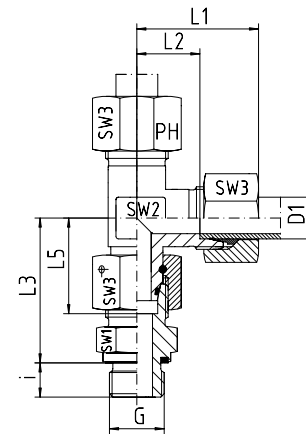

Series	Pressure PN	Tube O.D. D1	Thread G	Approx. Dimensions								Part code
				L1	L2	L3	L5	i	SW1	SW2	SW3	
L	500	6	M 10 x 1	27	12.0	34.5	26.0	8	14	12	14	EL-DKOL-06-M 10x1-wd
L	500	8	M 12 x 1.5	29	14.0	37.5	27.5	12	17	12	17	EL-DKOL-08-M 12x1.5-wd
L	500	10	M 14 x 1.5	30	15.0	40.0	29.0	12	19	14	19	EL-DKOL-10-M 14x1.5-wd
L	400	12	M 16 x 1.5	32	17.0	42.0	29.5	12	22	17	22	EL-DKOL-12-M 16x1.5-wd
L	400	15	M 18 x 1.5	36	21.0	46.0	32.5	12	24	19	27	EL-DKOL-15-M 18x1.5-wd
L	400	18	M 22 x 1.5	40	23.5	50.0	35.5	14	27	24	32	EL-DKOL-18-M 22x1.5-wd
L	250	22	M 26 x 1.5	44	27.5	55.0	38.5	16	32	27	36	EL-DKOL-22-M 26x1.5-wd
L	250	28	M 33 x 2	47	30.5	59.0	41.5	18	41	36	41	EL-DKOL-28-M 33x3-wd
L	250	35	M 42 x 2	56	34.5	68.5	51.0	20	50	41	50	EL-DKOL-35-M 42x2-wd
L	250	42	M 48 x 2	63	40.0	75.0	56.0	22	55	50	60	EL-DKOL-42-M 48x2-wd

Series	Pressure PN	Tube O.D. D1	Thread G	Approx. Dimensions								Part code
				L1	L2	L3	L5	i	SW1	SW2	SW3	
S	800	6	M 12 x 1.5	31	16.0	40.0	27.0	12	17	12	17	EL-DKOS-06-M 12x1.5-wd
S	800	8	M 14 x 1.5	32	17.0	42.5	27.5	12	19	14	19	EL-DKOS-08-M 14x1.5-wd
S	800	10	M 16 x 1.5	34	17.5	45.0	30.0	12	22	17	22	EL-DKOS-10-M 16x1.5-wd
S	630	12	M 18 x 1.5	38	21.5	48.0	31.0	12	24	17	24	EL-DKOS-12-M 18x1.5-wd
S	630	14	M 20 x 1.5	40	22.0	54.0	35.0	14	27	19	27	EL-DKOS-14-M 20x1.5-wd
S	630	16	M 22 x 1.5	43	24.5	55.0	36.5	14	27	24	30	EL-DKOS-16-M 22x1.5-wd
S	420	20	M 27 x 2	48	26.5	65.0	44.5	16	32	27	36	EL-DKOS-20-M 27x2-wd
S	420	25	M 33 x 2	54	30.0	73.0	50.0	18	41	36	46	EL-DKOS-25-M 33x2-wd
S	420	30	M 42 x 2	62	35.5	78.5	55.0	20	50	41	50	EL-DKOS-30-M 42x2-wd
S	420	38	M 48 x 2	72	41.0	89.0	63.0	22	55	50	60	EL-DKOS-38-M 48x2-wd

24° female and Viton O-ring
with a profile to W DIN 3861
BSP parallel male thread with
Viton elastomeric soft seal

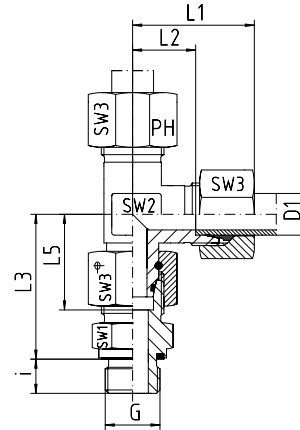

Series	Pressure PN	Tube O.D. D1	Thread G	Approx. Dimensions								Part code
				L1	L2	L3	L5	i	SW1	SW2	SW3	
L	500	6	G 1/8"	27	12.0	34.5	26.0	8	14	12	14	EL-DKOL-06-G 1/8"-wd
L	500	8	G 1/4"	29	14.0	37.5	27.5	12	19	12	17	EL-DKOL-08-G 1/4"-wd
L	500	10	G 1/4"	30	15.0	40.0	29.0	12	19	14	19	EL-DKOL-10-G 1/4"-wd
L	400	12	G 3/8"	32	17.0	42.0	29.5	12	22	17	22	EL-DKOL-12-G 3/8"-wd
L	400	15	G 1/2"	36	21.0	46.5	32.5	14	27	19	27	EL-DKOL-15-G 1/2"-wd
L	400	18	G 1/2"	40	23.5	50.0	35.5	14	27	24	32	EL-DKOL-18-G 1/2"-wd
L	250	22	G 3/4"	44	27.5	55.0	38.5	16	32	27	36	EL-DKOL-22-G 3/4"-wd
L	250	28	G 1"	47	30.5	59.0	41.5	18	41	36	41	EL-DKOL-28-G 1"-wd
L	250	35	G 1 1/4"	56	34.5	68.5	51.0	20	50	41	50	EL-DKOL-35-G 1 1/4"-wd
L	250	42	G 1 1/2"	63	40.0	75.0	56.0	22	55	50	60	EL-DKOL-42-G 1 1/2"-wd

Series	Pressure PN	Tube O.D. D1	Thread G	Approx. Dimensions								Part code
				L1	L2	L3	L5	i	SW1	SW2	SW3	
S	800	6	G 1/4"	31	16.0	40.0	27.0	12	19	12	17	EL-DKOS-06-G 1/4"-wd
S	800	8	G 1/4"	32	17.0	42.5	27.5	12	19	14	19	EL-DKOS-08-G 1/4"-wd
S	800	10	G 3/8"	34	17.5	45.0	30.0	12	22	17	22	EL-DKOS-10-G 3/8"-wd
S	630	12	G 3/8"	38	21.5	48.0	31.0	12	22	17	24	EL-DKOS-12-G 3/8"-wd
S	630	14	G 1/2"	40	22.0	54.0	35.0	14	27	19	27	EL-DKOS-14-G 1/2"-wd
S	630	16	G 1/2"	43	24.5	55.0	36.5	14	27	24	30	EL-DKOS-16-G 1/2"-wd
S	420	20	G 3/4"	48	26.5	65.0	44.5	16	32	27	36	EL-DKOS-20-G 3/4"-wd
S	420	25	G 1"	54	30.0	73.0	50.0	18	41	36	46	EL-DKOS-25-G 1"-wd
S	420	30	G 1 1/4"	62	35.5	78.5	55.0	20	50	41	50	EL-DKOS-30-G 1 1/4"-wd
S	420	38	G 1 1/2"	72	41.0	89.0	63.0	22	55	50	60	EL-DKOS-38-G 1 1/2"-wd

Straight female to male reducing coupling

BOOK INDEX

SECTION INDEX

24° female and Viton O-ring
with a profile to W DIN 3861

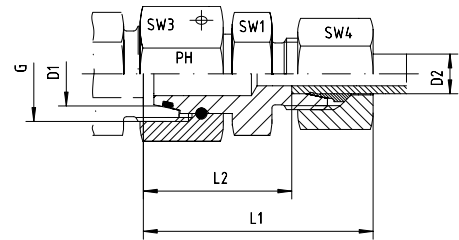
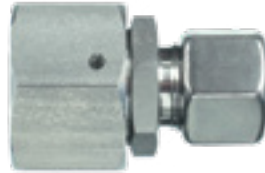

L series

Series	Pressure PN	Tube O.D.		Thread G	Approx. Dimensions					Part code
		D1	D2		L1	L2	SW1	SW3	SW4	
L	500	8	6	M 14 x 1.5	38	23.5	12	17	14	RED-DKOL-08/06
L	500	10	6	M 16 x 1.5	40	25.0	14	19	14	RED-DKOL-10/06
L	500	10	8	M 16 x 1.5	40	25.0	14	19	17	RED-DKOL-10/08
L	400	12	6	M 18 x 1.5	40	25.0	17	22	14	RED-DKOL-12/06
L	400	12	8	M 18 x 1.5	40	25.0	17	22	17	RED-DKOL-12/08
L	400	12	10	M 18 x 1.5	41	26.0	17	22	19	RED-DKOL-12/10
L	400	15	6	M 22 x 1.5	43	28.5	19	27	14	RED-DKOL-15/06
L	400	15	8	M 22 x 1.5	43	28.5	19	27	17	RED-DKOL-15/08
L	400	15	10	M 22 x 1.5	44	29.5	19	27	19	RED-DKOL-15/10
L	400	15	12	M 22 x 1.5	44	29.5	19	27	22	RED-DKOL-15/12
L	400	18	6	M 26 x 1.5	43	28.0	24	32	14	RED-DKOL-18/06
L	400	18	8	M 26 x 1.5	43	28.0	24	32	17	RED-DKOL-18/08
L	400	18	10	M 26 x 1.5	44	29.0	24	32	19	RED-DKOL-18/10
L	400	18	12	M 26 x 1.5	44	29.0	24	32	22	RED-DKOL-18/12
L	400	18	15	M 26 x 1.5	45	30.0	24	32	27	RED-DKOL-18/15
L	250	22	6	M 30 x 2	47	32.0	27	36	14	RED-DKOL-22/06
L	250	22	8	M 30 x 2	47	32.0	27	36	17	RED-DKOL-22/08
L	250	22	10	M 30 x 2	48	33.0	27	36	19	RED-DKOL-22/10
L	250	22	12	M 30 x 2	48	33.0	27	36	22	RED-DKOL-22/12
L	250	22	15	M 30 x 2	49	34.0	27	36	27	RED-DKOL-22/15
L	250	22	18	M 30 x 2	50	33.5	27	36	32	RED-DKOL-22/18
L	250	28	6	M 36 x 2	49	34.0	32	41	14	RED-DKOL-28/06
L	250	28	8	M 36 x 2	49	34.0	32	41	17	RED-DKOL-28/08
L	250	28	10	M 36 x 2	50	35.0	32	41	19	RED-DKOL-28/10
L	250	28	12	M 36 x 2	50	35.0	32	41	22	RED-DKOL-28/12
L	250	28	15	M 36 x 2	51	36.0	32	41	27	RED-DKOL-28/15
L	250	28	18	M 36 x 2	52	35.5	32	41	32	RED-DKOL-28/18
L	250	28	22	M 36 x 2	54	37.5	32	41	36	RED-DKOL-28/22
L	250	35	6	M 45 x 2	52	37.0	41	50	14	RED-DKOL-35/06
L	250	35	8	M 45 x 2	52	37.0	41	50	17	RED-DKOL-35/08
L	250	35	10	M 45 x 2	53	38.0	41	50	19	RED-DKOL-35/10
L	250	35	12	M 45 x 2	53	38.0	41	50	22	RED-DKOL-35/12
L	250	35	15	M 45 x 2	54	39.0	41	50	27	RED-DKOL-35/15
L	250	35	18	M 45 x 2	55	38.5	41	50	32	RED-DKOL-35/18
L	250	35	22	M 45 x 2	57	40.5	41	50	36	RED-DKOL-35/22
L	250	35	28	M 45 x 2	57	40.5	41	50	41	RED-DKOL-35/28
L	250	42	6	M 52 x 2	55	40.5	50	60	14	RED-DKOL-42/06
L	250	42	8	M 52 x 2	55	40.5	50	60	17	RED-DKOL-42/08
L	250	42	10	M 52 x 2	56	41.5	50	60	19	RED-DKOL-42/10
L	250	42	12	M 52 x 2	56	41.5	50	60	22	RED-DKOL-42/12
L	250	42	15	M 52 x 2	58	42.5	50	60	27	RED-DKOL-42/15
L	250	42	18	M 52 x 2	58	42.0	50	60	32	RED-DKOL-42/18
L	250	42	22	M 52 x 2	60	44.0	50	60	36	RED-DKOL-42/22
L	250	42	28	M 52 x 2	61	44.0	50	60	41	RED-DKOL-42/28
L	250	42	35	M 52 x 2	65	43.0	50	60	50	RED-DKOL-42/35

Straight female to male reducing coupling

BOOK INDEX

SECTION INDEX

24° female and Viton O-ring
with a profile to W DIN 3861

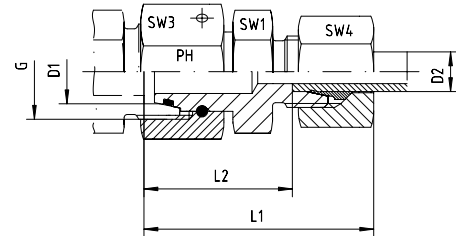
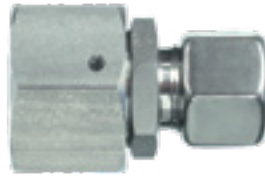

S series

Series	Pressure PN	Tube O.D.		Thread G	Approx. Dimensions					Part code
		D1	D2		L1	L2	SW1	SW3	SW4	
S	800	8	6	M 16 x 1.5	42	27.0	14	19	17	RED-DKOS-08/06
S	800	10	6	M 18 x 1.5	42	27.5	17	22	17	RED-DKOS-10/06
S	800	10	8	M 18 x 1.5	42	27.5	17	22	19	RED-DKOS-10/08
S	630	12	6	M 20 x 1.5	44	29.0	17	24	17	RED-DKOS-12/06
S	630	12	8	M 20 x 1.5	44	29.0	17	24	19	RED-DKOS-12/08
S	630	12	10	M 20 x 1.5	46	29.5	19	24	22	RED-DKOS-12/10
S	630	14	6	M 22 x 1.5	46	31.5	19	27	17	RED-DKOS-14/06
S	630	14	8	M 22 x 1.5	46	31.5	19	27	19	RED-DKOS-14/08
S	630	14	10	M 22 x 1.5	47	31.0	19	27	22	RED-DKOS-14/10
S	630	14	12	M 22 x 1.5	47	31.0	22	27	24	RED-DKOS-14/12
S	630	16	6	M 24 x 1.5	47	32.0	22	30	17	RED-DKOS-16/06
S	630	16	8	M 24 x 1.5	47	32.0	22	30	19	RED-DKOS-16/08
S	630	16	10	M 24 x 1.5	48	31.5	22	30	22	RED-DKOS-16/10
S	630	16	12	M 24 x 1.5	48	31.5	22	30	24	RED-DKOS-16/12
S	630	16	14	M 24 x 1.5	51	33.0	22	30	27	RED-DKOS-16/14
S	420	20	6	M 30 x 2	51	36.0	27	36	17	RED-DKOS-20/06
S	420	20	8	M 30 x 2	51	36.0	27	36	19	RED-DKOS-20/08
S	420	20	10	M 30 x 2	52	35.5	27	36	22	RED-DKOS-20/10
S	420	20	12	M 30 x 2	52	35.5	27	36	24	RED-DKOS-20/12
S	420	20	14	M 30 x 2	55	37.0	27	36	27	RED-DKOS-20/14
S	420	20	16	M 30 x 2	55	36.5	27	36	30	RED-DKOS-20/16
S	420	25	6	M 36 x 2	53	38.5	32	41	17	RED-DKOS-25/06
S	420	25	8	M 36 x 2	53	38.5	32	41	19	RED-DKOS-25/08
S	420	25	10	M 36 x 2	54	38.0	32	41	22	RED-DKOS-25/10
S	420	25	12	M 36 x 2	54	38.0	32	41	24	RED-DKOS-25/12
S	420	25	14	M 36 x 2	57	39.5	32	41	27	RED-DKOS-25/14
S	420	25	16	M 36 x 2	57	39.0	32	41	30	RED-DKOS-25/16
S	420	25	20	M 36 x 2	61	39.0	32	41	36	RED-DKOS-25/20
S	420	30	6	M 42 x 2	59	44.0	41	50	17	RED-DKOS-30/06
S	420	30	8	M 42 x 2	59	44.0	41	50	19	RED-DKOS-30/08
S	420	30	10	M 42 x 2	60	43.5	41	50	22	RED-DKOS-30/10
S	420	30	12	M 42 x 2	60	43.5	41	50	24	RED-DKOS-30/12
S	420	30	14	M 42 x 2	63	45.0	41	50	27	RED-DKOS-30/14
S	420	30	16	M 42 x 2	63	44.5	41	50	30	RED-DKOS-30/16
S	420	30	20	M 42 x 2	66	44.5	41	50	36	RED-DKOS-30/20
S	420	30	25	M 42 x 2	69	45.0	41	50	46	RED-DKOS-30/25
S	420	38	6	M 52 x 2	63	47.0	50	60	17	RED-DKOS-38/06
S	420	38	8	M 52 x 2	63	47.0	50	60	19	RED-DKOS-38/08
S	420	38	10	M 52 x 2	63	47.0	50	60	22	RED-DKOS-38/10
S	420	38	12	M 52 x 2	63	47.0	50	60	24	RED-DKOS-38/12
S	420	38	14	M 52 x 2	66	48.5	50	60	27	RED-DKOS-38/14
S	420	38	16	M 52 x 2	66	48.0	50	60	30	RED-DKOS-38/16
S	420	38	20	M 52 x 2	70	48.0	50	60	36	RED-DKOS-38/20
S	420	38	25	M 52 x 2	73	48.5	50	60	46	RED-DKOS-38/25
S	420	38	30	M 52 x 2	76	49.0	50	60	50	RED-DKOS-38/30

Swivel female to metric parallel male

BOOK INDEX

SECTION INDEX

24° female and Viton O-ring
with a profile to W DIN 3861

Metric parallel male thread with
Viton elastomeric soft seal

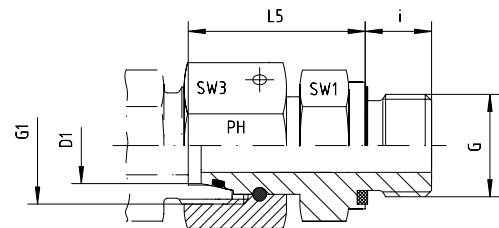

Series	Pressure PN	Tube O.D. D1	Thread		Approx. Dimensions				Part code
			G	G1	L5	i	SW1	SW3	
L	500	6	M 10 x 1	M 12 x 1.5	24.5	8	14	14	EGE-DKOL-06-M 10x1-wd
L	500	8	M 12 x 1.5	M 14 x 1.5	26.5	12	17	17	EGE-DKOL-08-M 12x1.5-wd
L	500	10	M 14 x 1.5	M 16 x 1.5	27.5	12	19	19	EGE-DKOL-10-M 14x1.5-wd
L	400	12	M 16 x 1.5	M 18 x 1.5	30.5	12	22	22	EGE-DKOL-12-M 16x1.5-wd
L	400	15	M 18 x 1.5	M 22 x 1.5	31.5	12	24	27	EGE-DKOL-15-M 18x1.5-wd
L	400	18	M 22 x 1.5	M 26 x 1.5	31.5	14	27	32	EGE-DKOL-18-M 22x1.5-wd
L	250	22	M 26 x 1.5	M 30 x 2	32.5	16	32	36	EGE-DKOL-22-M 26x1.5-wd
L	250	28	M 33 x 2	M 36 x 2	35.0	18	41	41	EGE-DKOL-28-M 33x2-wd
L	250	35	M 42 x 2	M 45 x 2	42.5	20	50	50	EGE-DKOL-35-M 42x2-wd
L	250	42	M 48 x 2	M 52 x 2	46.5	22	55	60	EGE-DKOL-42-M 48x2-wd

Series	Pressure PN	Tube O.D. D1	Thread		Approx. Dimensions				Part code
			G	G1	L5	i	SW1	SW3	
S	800	6	M 12 x 1.5	M 14 x 1.5	27.0	12	17	17	EGE-DKOS-06-M 12x1.5-wd
S	800	8	M 14 x 1.5	M 16 x 1.5	29.5	12	19	19	EGE-DKOS-08-M 14x1.5-wd
S	800	10	M 16 x 1.5	M 18 x 1.5	32.0	12	22	22	EGE-DKOS-10-M 16x1.5-wd
S	630	12	M 18 x 1.5	M 20 x 1.5	34.0	12	24	24	EGE-DKOS-12-M 18x1.5-wd
S	630	14	M 20 x 1.5	M 22 x 1.5	36.5	14	27	27	EGE-DKOS-14-M 20x1.5-wd
S	630	16	M 22 x 1.5	M 24 x 1.5	37.0	14	27	30	EGE-DKOS-16-M 22x1.5-wd
S	420	20	M 27 x 2	M 30 x 2	43.0	16	32	36	EGE-DKOS-20-M 27x2-wd
S	420	25	M 33 x 2	M 36 x 2	48.0	18	41	46	EGE-DKOS-25-M 33x2-wd
S	420	30	M 42 x 2	M 42 x 2	51.0	20	50	50	EGE-DKOS-30-M 42x2-wd
S	420	38	M 48 x 2	M 52 x 2	60.0	22	55	60	EGE-DKOS-38-M 48x2-wd

9

Swivel female to BSP parallel male

BOOK INDEX

SECTION INDEX

24° female and Viton O-ring
with a profile to W DIN 3861
BSP parallel male thread with
Viton elastomeric soft seal

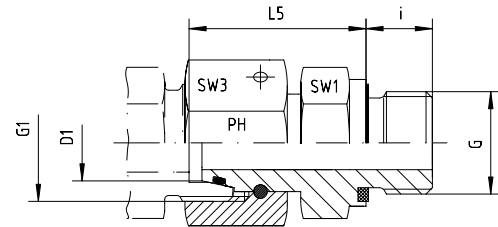

Series	Pressure PN	Tube O.D. D1	Thread		Approx. Dimensions				Part code
			G	G1	L5	i	SW1	SW3	
L	500	6	G 1/8"	M 12 x 1.5	24.5	8	14	14	EGE-DKOL-06-G 1/8"-wd
L	500	6	G 1/4"	M 12 x 1.5	27.0	12	19	14	EGE-DKOL-06-G 1/4"-wd
L	400	6	G 3/8"	M 12 x 1.5	28.0	12	22	14	EGE-DKOL-06-G 3/8"-wd
L	500	8	G 1/8"	M 14 x 1.5	25.5	8	14	17	EGE-DKOL-08-G 1/8"-wd
L	500	8	G 1/4"	M 14 x 1.5	29.5	12	19	17	EGE-DKOL-08-G 1/4"-wd
L	400	8	G 3/8"	M 14 x 1.5	29.5	12	22	17	EGE-DKOL-08-G 3/8"-wd
L	400	8	G 1/2"	M 14 x 1.5	29.0	14	27	17	EGE-DKOL-08-G 1/2"-wd
L	500	10	G 1/8"	M 16 x 1.5	25.5	8	14	19	EGE-DKOL-10-G 1/8"-wd
L	500	10	G 1/4"	M 16 x 1.5	27.5	12	19	19	EGE-DKOL-10-G 1/4"-wd
L	400	10	G 3/8"	M 16 x 1.5	30.0	12	22	19	EGE-DKOL-10-G 3/8"-wd
L	400	10	G 1/2"	M 16 x 1.5	30.0	14	27	19	EGE-DKOL-10-G 1/2"-wd
L	400	12	G 1/8"	M 18 x 1.5	26.0	8	17	22	EGE-DKOL-12-G 1/8"-wd
L	400	12	G 1/4"	M 18 x 1.5	28.0	12	19	22	EGE-DKOL-12-G 1/4"-wd
L	400	12	G 3/8"	M 18 x 1.5	34.0	12	22	22	EGE-DKOL-12-G 3/8"-wd
L	400	12	G 1/2"	M 18 x 1.5	34.5	14	27	22	EGE-DKOL-12-G 1/2"-wd
L	400	15	G 3/8"	M 22 x 1.5	35.0	12	24	27	EGE-DKOL-15-G 3/8"-wd
L	400	15	G 1/2"	M 22 x 1.5	35.0	14	27	27	EGE-DKOL-15-G 1/2"-wd
L	250	15	G 3/4"	M 22 x 1.5	48.0	16	32	27	EGE-DKOL-15-G 3/4"-wd
L	400	18	G 3/8"	M 26 x 1.5	34.0	12	24	32	EGE-DKOL-18-G 3/8"-wd
L	400	18	G 1/2"	M 26 x 1.5	31.5	14	27	32	EGE-DKOL-18-G 1/2"-wd
L	315	18	G 3/4"	M 26 x 1.5	33.0	16	32	32	EGE-DKOL-18-G 3/4"-wd
L	250	22	G 1/2"	M 30 x 2	32.0	14	27	36	EGE-DKOL-22-G 1/2"-wd
L	250	22	G 3/4"	M 30 x 2	32.5	16	32	36	EGE-DKOL-22-G 3/4"-wd
L	250	22	G 1"	M 30 x 2	33.0	18	41	36	EGE-DKOL-22-G 1"-wd
L	250	28	G 3/4"	M 36 x 2	35.0	16	32	41	EGE-DKOL-28-G 3/4"-wd
L	250	28	G 1"	M 36 x 2	35.0	18	41	41	EGE-DKOL-28-G 1"-wd
L	250	35	G 1 1/4"	M 45 x 2	42.5	20	50	50	EGE-DKOL-35-G 1 1/4"-wd
L	250	42	G 1 1/4"	M 52 x 2	40.5	20	50	60	EGE-DKOL-42-G 1 1/4"-wd
L	250	42	G 1 1/2"	M 52 x 2	46.5	22	55	60	EGE-DKOL-42-G 1 1/2"-wd

Series	Pressure PN	Tube O.D. D1	Thread		Approx. Dimensions				Part code
			G	G1	L5	i	SW1	SW3	
S	800	6	G 1/4"	M 14 x 1.5	27.0	12	19	17	EGE-DKOS-06-G 1/4"-wd
S	800	8	G 1/4"	M 16 x 1.5	29.5	12	19	19	EGE-DKOS-08-G 1/4"-wd
S	800	8	G 3/8"	M 16 x 1.5	29.5	12	22	19	EGE-DKOS-08-G 3/8"-wd
S	800	10	G 1/4"	M 18 x 1.5	27.5	12	19	22	EGE-DKOS-10-G 1/4"-wd
S	800	10	G 3/8"	M 18 x 1.5	32.0	12	22	22	EGE-DKOS-10-G 3/8"-wd
S	630	10	G 1/2"	M 18 x 1.5	32.0	14	27	22	EGE-DKOS-10-G 1/2"-wd
S	630	12	G 1/4"	M 20 x 1.5	42.0	12	19	24	EGE-DKOS-12-G 1/4"-wd
S	630	12	G 3/8"	M 20 x 1.5	34.0	12	22	24	EGE-DKOS-12-G 3/8"-wd
S	630	12	G 1/2"	M 20 x 1.5	34.5	14	27	24	EGE-DKOS-12-G 1/2"-wd
S	630	14	G 1/2"	M 22 x 1.5	36.5	14	27	27	EGE-DKOS-14-G 1/2"-wd
S	630	16	G 3/8"	M 24 x 1.5	37.0	12	24	30	EGE-DKOS-16-G 3/8"-wd
S	630	16	G 1/2"	M 24 x 1.5	37.0	14	27	30	EGE-DKOS-16-G 1/2"-wd
S	420	16	G 3/4"	M 24 x 1.5	39.0	16	32	30	EGE-DKOS-16-G 3/4"-wd
S	420	20	G 1/2"	M 30 x 2	38.0	14	27	36	EGE-DKOS-20-G 1/2"-wd
S	420	20	G 3/4"	M 30 x 2	43.0	16	32	36	EGE-DKOS-20-G 3/4"-wd
S	420	20	G 1"	M 30 x 2	55.0	18	41	36	EGE-DKOS-20-G 1"-wd
S	420	25	G 3/4"	M 36 x 2	58.0	16	32	46	EGE-DKOS-25-G 3/4"-wd
S	420	25	G 1"	M 36 x 2	48.0	18	41	46	EGE-DKOS-25-G 1"-wd
S	420	30	G 1"	M 42 x 2	46.0	18	41	50	EGE-DKOS-30-G 1"-wd
S	420	30	G 1 1/4"	M 42 x 2	51.0	20	50	50	EGE-DKOS-30-G 1 1/4"-wd
S	420	38	G 1 1/2"	M 52 x 2	60.0	22	55	60	EGE-DKOS-38-G 1 1/2"-wd

Swivel female to NPT male

BOOK INDEX

SECTION INDEX

24° female and Viton O-ring
with a profile to W DIN 3861
NPT male

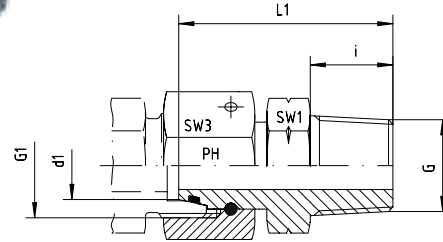

Series	Pressure PN	Tube O.D. D1	Thread		Approx. Dimensions				Part code
			G	G1	L1	i	SW1	SW3	
L	500	6	1/8" NPT	M 12 x 1.5	32.0	10.0	12	14	EGE-DKOL-06-NPT-1/8"
L	500	6	1/4" NPT	M 12 x 1.5	38.0	15.0	14	14	EGE-DKOL-06-NPT-1/4"
L	500	8	1/4" NPT	M 14 x 1.5	42.5	15.0	14	17	EGE-DKOL-08-NPT-1/4"
L	500	10	1/4" NPT	M 16 x 1.5	42.5	15.0	14	19	EGE-DKOL-10-NPT-1/4"
L	400	10	3/8" NPT	M 16 x 1.5	43.0	15.3	19	19	EGE-DKOL-10-NPT-3/8"
L	400	12	1/4" NPT	M 18 x 1.5	40.0	15.0	17	22	EGE-DKOL-12-NPT-1/4"
L	400	12	3/8" NPT	M 18 x 1.5	40.0	15.3	19	22	EGE-DKOL-12-NPT-3/8"
L	400	12	1/2" NPT	M 18 x 1.5	47.0	20.0	22	22	EGE-DKOL-12-NPT-1/2"
L	400	15	1/2" NPT	M 22 x 1.5	49.0	20.0	22	27	EGE-DKOL-15-NPT-1/2"
L	400	18	1/2" NPT	M 26 x 1.5	49.0	20.0	24	32	EGE-DKOL-18-NPT-1/2"
L	250	22	1/2" NPT	M 30 x 2	49.0	20.0	27	36	EGE-DKOL-22-NPT-1/2"
L	250	22	3/4" NPT	M 30 x 2	50.0	20.0	27	36	EGE-DKOL-22-NPT-3/4"
L	250	28	1" NPT	M 36 x 2	61.0	25.0	36	41	EGE-DKOL-28-NPT-1"
L	250	35	1 1/4" NPT	M 45 x 2	60.5	25.5	46	50	EGE-DKOL-35-NPT-1 1/4"
L	250	42	1 1/2" NPT	M 52 x 2	63.0	26.0	50	60	EGE-DKOL-42-NPT-1 1/2"

Series	Pressure PN	Tube O.D. D1	Thread		Approx. Dimensions				Part code
			G	G1	L1	i	SW1	SW3	
S	800	6	1/4" NPT	M 14 x 1.5	38.0	15.0	14	17	EGE-DKOS-06-NPT-1/4"
S	800	8	1/4" NPT	M 16 x 1.5	39.0	15.0	14	19	EGE-DKOS-08-NPT-1/4"
S	800	10	3/8" NPT	M 18 x 1.5	40.0	15.3	19	22	EGE-DKOS-10-NPT-3/8"
S	630	12	1/4" NPT	M 20 x 1.5	41.5	15.0	17	24	EGE-DKOS-12-NPT-1/4"
S	630	12	3/8" NPT	M 20 x 1.5	41.5	15.3	19	24	EGE-DKOS-12-NPT-3/8"
S	630	12	1/2" NPT	M 20 x 1.5	48.0	20.0	22	24	EGE-DKOS-12-NPT-1/2"
S	630	14	1/2" NPT	M 22 x 1.5	48.0	20.0	22	27	EGE-DKOS-14-NPT-1/2"
S	630	16	3/8" NPT	M 24 x 1.5	45.0	15.3	22	30	EGE-DKOS-16-NPT-3/8"
S	630	16	1/2" NPT	M 24 x 1.5	49.0	20.0	22	30	EGE-DKOS-16-NPT-1/2"
S	420	16	3/4" NPT	M 24 x 1.5	49.0	20.0	27	30	EGE-DKOS-16-NPT-3/4"
S	420	20	3/4" NPT	M 30 x 2	52.0	20.0	27	36	EGE-DKOS-20-NPT-3/4"
S	420	25	1" NPT	M 36 x 2	66.0	25.0	36	46	EGE-DKOS-25-NPT-1"
S	420	30	1 1/4" NPT	M 42 x 2	65.5	25.5	46	50	EGE-DKOS-30-NPT-1 1/4"
S	420	38	1 1/2" NPT	M 52 x 2	66.0	26.0	50	60	EGE-DKOS-38-NPT-1 1/2"

9

Swivel female to gauge female

BOOK INDEX

SECTION INDEX

24° female and Viton O-ring
with a profile to W DIN 3861

Supplied with metallic internal
sealing ring

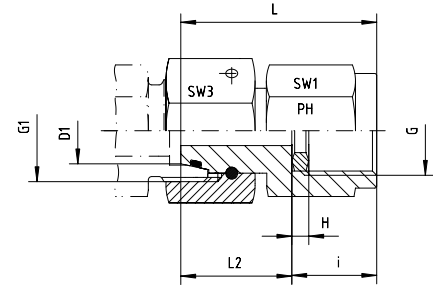

Series	Pressure PN	Tube O.D. D1	Thread		Approx. Dimensions					Part code
			G	G1	L	i	H	SW1	SW3	
L	315	6	1/4"	M 12 x 1.5	35.5	14.5	4.5	19	14	MVE-DKOL-06-G 1/4"
L	315	6	1/2"	M 12 x 1.5	43.0	20.0	5.0	27	14	MVE-DKOL-06-G 1/2"
L	315	8	1/4"	M 14 x 1.5	35.5	14.5	4.5	19	17	MVE-DKOL-08-G 1/4"
L	315	8	1/2"	M 14 x 1.5	43.7	20.0	5.0	27	17	MVE-DKOL-08-G 1/2"
L	315	10	1/4"	M 16 x 1.5	36.0	14.5	4.5	19	19	MVE-DKOL-10-G 1/4"
L	315	10	1/2"	M 16 x 1.5	43.7	20.0	5.0	27	19	MVE-DKOL-10-G 1/2"
L	315	12	1/4"	M 18 x 1.5	36.0	14.5	4.5	19	22	MVE-DKOL-12-G 1/4"
L	315	12	1/2"	M 18 x 1.5	44.0	20.0	5.0	27	22	MVE-DKOL-12-G 1/2"

Series	Pressure PN	Tube O.D. D1	Thread		Approx. Dimensions					Part code
			G	G1	L	i	H	SW1	SW3	
S	630	6	1/4"	M 14 x 1.5	36.0	14.5	4.5	19	17	MVE-DKOS-06-G 1/4"
S	630	6	1/2"	M 14 x 1.5	43.0	20.0	5.0	27	17	MVE-DKOS-06-G 1/2"
S	630	8	1/4"	M 16 x 1.5	37.5	14.5	4.5	19	19	MVE-DKOS-08-G 1/4"
S	630	8	1/2"	M 16 x 1.5	43.0	20.0	5.0	27	19	MVE-DKOS-08-G 1/2"
S	630	10	1/4"	M 18 x 1.5	37.5	14.5	4.5	19	22	MVE-DKOS-10-G 1/4"
S	630	10	1/2"	M 18 x 1.5	43.5	20.0	5.0	27	22	MVE-DKOS-10-G 1/2"
S	630	12	1/4"	M 20 x 1.5	39.0	14.5	4.5	19	24	MVE-DKOS-12-G 1/4"
S	630	12	1/2"	M 20 x 1.5	45.0	20.0	5.0	27	24	MVE-DKOS-12-G 1/2"

Distance adapter

BOOK INDEX

SECTION INDEX

24° female and Viton
O-ring with a profile to
W DIN 3861

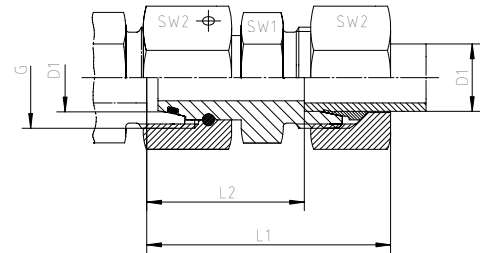

Series	Pressure PN	Tube O.D. D1	Thread G	Approx. Dimensions				Part code
				L1	L2	SW1	SW2	
L	500	6	M 12 x 1.5	51.0	36.0	12	14	DA-DKOL-06
L	500	8	M 14 x 1.5	51.0	36.0	14	17	DA-DKOL-08
L	500	10	M 16 x 1.5	51.0	36.0	17	19	DA-DKOL-10
L	400	12	M 18 x 1.5	51.0	36.0	19	22	DA-DKOL-12
L	400	15	M 22 x 1.5	51.0	36.0	24	27	DA-DKOL-15
L	400	18	M 26 x 1.5	52.0	36.0	27	32	DA-DKOL-18
L	250	22	M 30 x 2	56.0	40.0	32	36	DA-DKOL-22
L	250	28	M 36 x 2	57.0	40.0	41	41	DA-DKOL-28
L	250	35	M 45 x 2	72.0	50.0	46	50	DA-DKOL-35
L	250	42	M 52 x 2	83.0	60.0	55	60	DA-DKOL-42

Series	Pressure PN	Tube O.D. D1	Thread G	Approx. Dimensions				Part code
				L1	L2	SW1	SW2	
S	800	6	M 14 x 1.5	51.0	36.0	14	17	DA-DKOS-06
S	800	8	M 16 x 1.5	51.0	36.0	17	19	DA-DKOS-08
S	800	10	M 18 x 1.5	52.0	36.0	19	22	DA-DKOS-10
S	630	12	M 20 x 1.5	52.0	36.0	22	24	DA-DKOS-12
S	630	14	M 22 x 1.5	58.0	40.0	24	27	DA-DKOS-14
S	630	16	M 24 x 1.5	58.0	40.0	27	30	DA-DKOS-16
S	420	20	M 30 x 2	68.0	46.0	32	36	DA-DKOS-20
S	420	25	M 36 x 2	74.0	50.0	41	46	DA-DKOS-25
S	420	30	M 42 x 2	83.0	56.0	46	50	DA-DKOS-30
S	420	38	M 52 x 2	91.0	60.0	55	60	DA-DKOS-38

9